

Sun FLeX Series Solenoid Valves

HIGH RELIABILITY

10 million on-off operational cycles

LOW INTERNAL LEAKAGE

Less than one drop per minute

USE WITH ANY OF THREE COILS

Includes options for energy savings & for hazardous locations

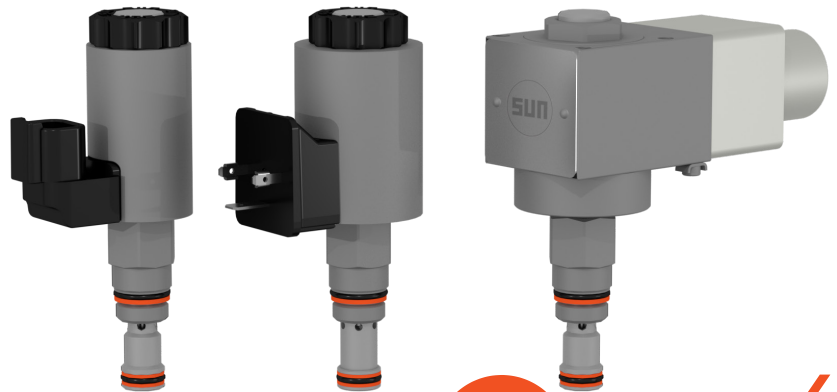

DTBF

5000 psi (350 bar)
T-162A cavity

2-WAY, DIRECT-ACTING,
SOLENOID-OPERATED DIRECTIONAL
BLOCKING POPPET VALVE

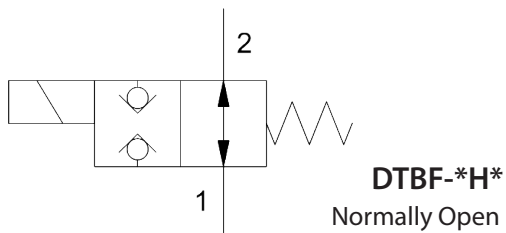
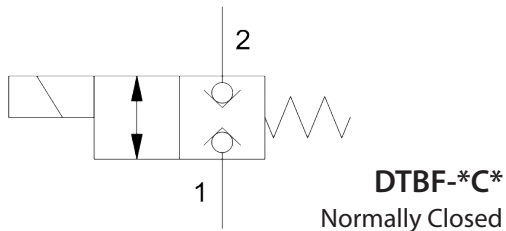

TABLE OF CONTENTS

Valve Functionality	2
Technical Features	2
Model Configurations & Options	3
Technical Specifications	4
Performance Curves	5
Dimensional Drawings	6
Cavity Drawings/Tooling	7
Additional Information	8

sunhydraulics.com/model/DTBF

DTBF 2-WAY, DIRECT-ACTING, SOLENOID-OPERATED DIRECTIONAL BLOCKING POPPET VALVE

SERIES 0, CAVITY: T-162A

The 2/2 directional poppet valves are direct acting and feature a pressure-balanced design. Both ports can be loaded with an operating pressure up to 5000 psi (350 bar). They comprise a hex body (3), solenoid with coil (2), poppet (5), pin (4), spring (6), and coil nut (1).

DTBF-*C* (normally closed)

Function: When de-energized, the poppet (5) is pulled against the valve seat (3) by the spring (6), closing the valve and blocking flow. When energized, the solenoid with coil (2) pushes the poppet off the seat and opens the valve, allowing bi-directional flow.

DTBF-*H* (normally open)

Function: When the coil (2) is de-energized, the spring (6) holds the poppet (5) away from the seat (3), allowing bi-directional flow. When energized, the poppet is pushed into the seat by the solenoid, and the valve is closed, blocking flow.

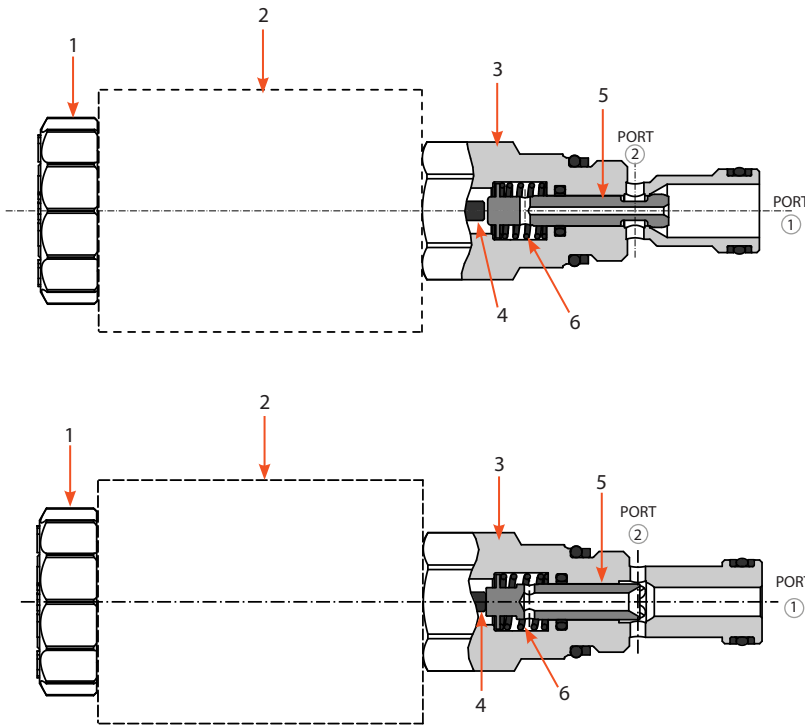

TECHNICAL FEATURES

- All FLeX Series valves incorporate the Sun floating-style construction to minimize the possibility of internal parts binding due to excessive installation torque and/or cavity/cartridge machining variations.
- Designed and tested to 10 million on-off operational cycles.
- Meets new NFPA test standard T2.6.1 R2014 for fatigue and burst pressure ratings.
- Higher flow rates than competing valves of similar size.
- Extremely low leakage – 0.004 in³ (0.07 cc³)/min (1 drop/min)
- Designed using CFD fluid simulation for optimized geometries.
- Zinc-nickel plating standard for 1000-hour salt fog protection.
- Direct actuated and requires no minimum hydraulic pressure for operation.
- Available with a manual push-version override option.
- Suitable for load-holding applications when using the normally closed option. In the event of power failure, the valve will close.
- A wide variety of coil termination and voltage options are available, with and without surge protection. See the CONFIGURATION section.
- Normally closed DTBF valves can be used with any of the FLeX coils, which includes low-power, high-power and explosion-proof coils. Normally open DTBF valves can be used with the high-power and explosion-proof coils.
- Coil connector options offer ratings up to IP69K. See individual coil product pages for details.

MODEL CODE EXPLANATION

Sun cartridges have a base seven-digit part number. Each of the digits in the sequence has significance as shown in the model code explanation below. Available options and

modifiers for specific cartridges, manifolds, and valve packages are shown on the individual product pages and data sheets. All modifiers are not applicable for every model.

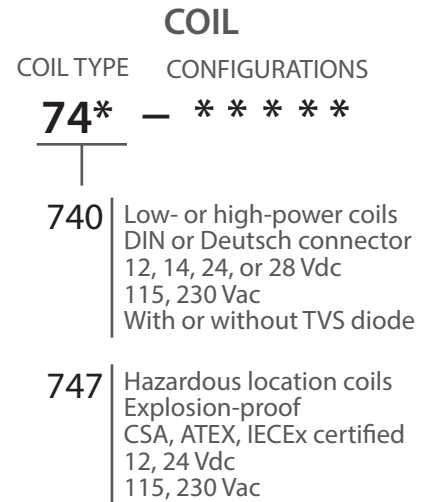
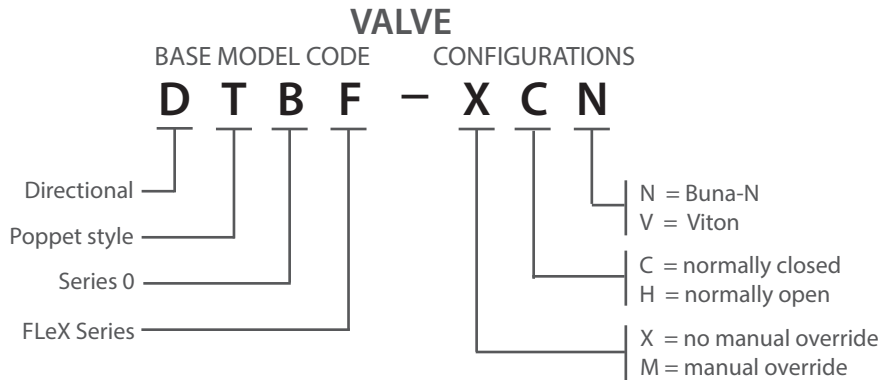

Important Note:

When performing model code searches on www.sunhydraulics.com, do not include setting(s). When ordering, no spaces or dashes are used.

See individual coil data sheets for full coil configuration.

COMPATIBLE FLeX SERIES COILS

Note that the normally closed version (DTBF-*C*) is compatible with both low- and high-power coils and the hazardous location coils. The normally open version (DTBF-*H*) is compatible with the high-power coils and the hazardous location coils.

Low-Power (17-W) & High-Power (25-W) Coils

Voltage	DIN 43650 Form A (IP65/IP67)		Deutsch DT04-2P (IP69K)		Resistance @20°C (ohms) ±10% (with diode*)	TVS Diode (Nominal) Breakdown Voltage (with diode*)
	High-Power	Low-Power	High-Power	Low-Power		
12 Vdc	740-212	740-212L	740-912	740-912L	5.8 ohms	68 Vdc
14 Vdc	740-214	740-214L	740-914	740-914L	7.8 ohms	68 Vdc
24 Vdc	740-224	740-224L	740-924	740-924L	23.0 ohms	68 Vdc
28 Vdc	740-228	740-228L	740-928	740-928L	31.4 ohms	68 Vdc
115 Vac	740-211	740-211L	N/A	N/A	416 ohms	250 Vac
230 Vac	740-223	740-223L	N/A	N/A	1686 ohms	400 Vac

* Above model codes are shown without transient voltage suppression (TVS) diodes. To order FLeX coils with a TVS diode, append model code with "D" (Example: 740-212LD).

Hazardous Location, Explosion-Proof (30-W) Coils

Voltage	M20 x 1.5 180°	M20 x 1.5 90°	1/2" NPT 180°	1/2" NPT 90°	Wattage @ 20°C	Circuitry
12 Vdc	747-JM12BD	747-JM12CD	747-JN12BD	747-JN12CD	29.6 W	With diode
24 Vdc	747-JM24BD	747-JM24CD	747-JN24BD	747-JN24CD	29.9 W	With diode
115 Vac	747-JM11BD	747-JM11CD	747-JN11BD	747-JN11CD	29.7 W	Rectified
230 Vac	747-JM23BD	747-JM23CD	747-JN23BD	747-JN23CD	28.9 W	Rectified



2-WAY, DIRECT-ACTING, SOLENOID-OPERATED
DIRECTIONAL BLOCKING POPPET VALVE

SERIES 0, CAVITY: T-162A

TECHNICAL SPECIFICATIONS	
Sun Cavity	T-162A
Sun Cartridge Series	Series 0
Maximum Flow Rate/Capacity	9 gpm (34.1 L/min)*
Nominal Flow Rate/Capacity	Low-power coil (normally closed): 0.9 gpm (3.4 L/min)** High-power coil (normally closed): 2.0 gpm (11.7 L/min) High-power coil (normally open): 0.9 gpm (3.4 L/min)
Maximum Operating Pressure	5000 psi (350 bar)
Response Time - Typical	50 ms (open & close)
Maximum Internal Leakage at 110 SUS (24 cSt) at 5000 psi (350 bar)	0.004 in ³ (0.07 cc ³)/min (1 drop/min)
Switching Frequency (Maximum)	15,000 cycles/hour
Manual Override Option	Yes
Viscosity Range	2,8 to 380 cSt or 35 to 2000 SUS
Filtration	Minimum cleanliness (ISO 4406 1999, 4/6/14 µm) 19/17/14
Valve Hex Size	0.75 in (19,1 mm)
Valve Installation Torque	20 - 25 lbf ft (27 - 34 N-m)
Mounting Position	No restrictions
Valve Weight (excluding coil)	5.6 oz (159 g)
Seal Kit - Viton	990-162-006
Seal Kit - Buna	990-162-007

* See performance curves on P 5 for more details.

** The low-power coil can be used only on the DTBF-*C* normally closed version of the valve.

TYPICAL PERFORMANCE CURVES

DTBF-*C*
(Normally closed)

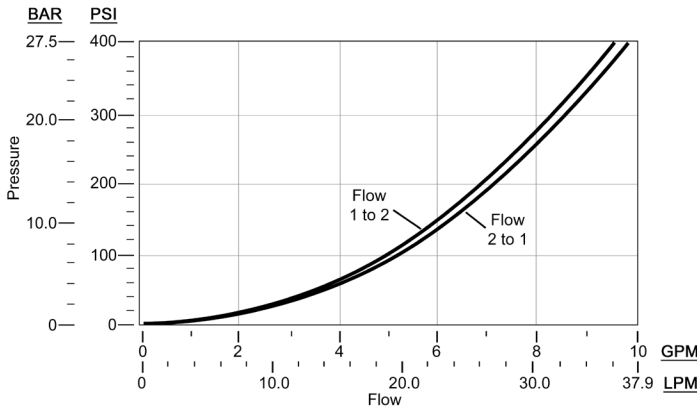

DTBF-*H*
(Normally open)

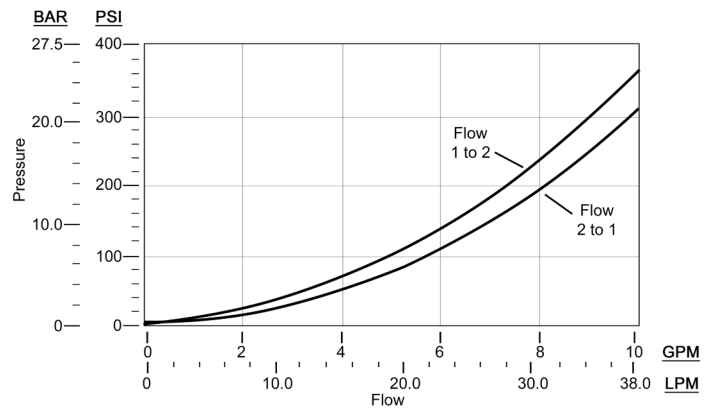

PERFORMANCE LIMITS @15% UNDERVOLTAGE & STABILIZED COIL TEMP

DTBF-*C* w/Low-Power Coil
(Normally closed)

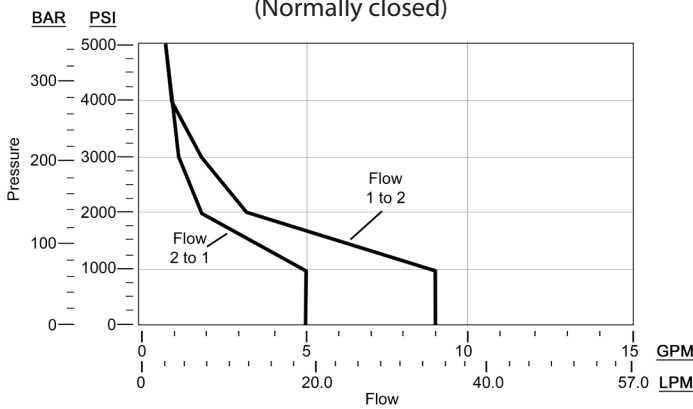

DTBF-*C* w/High-Power Coil
(Normally closed)

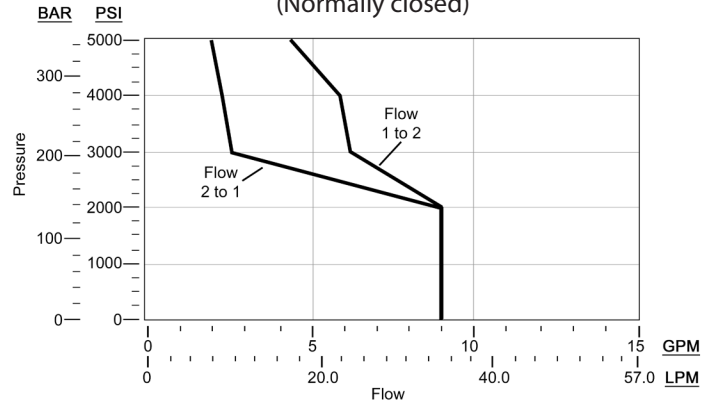

DTBF-*H* w/High-Power Coil
(Normally open)

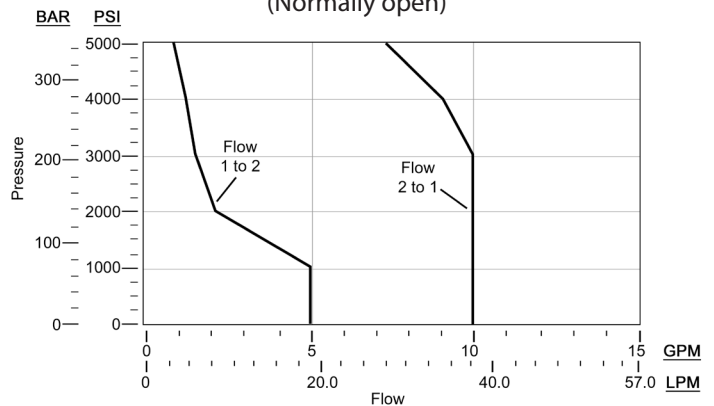

Note: The DTBF-*H* normally open valve cannot use the low-power coil.

DTBF WITH 740 SERIES LOW- & HIGH-POWER COILS

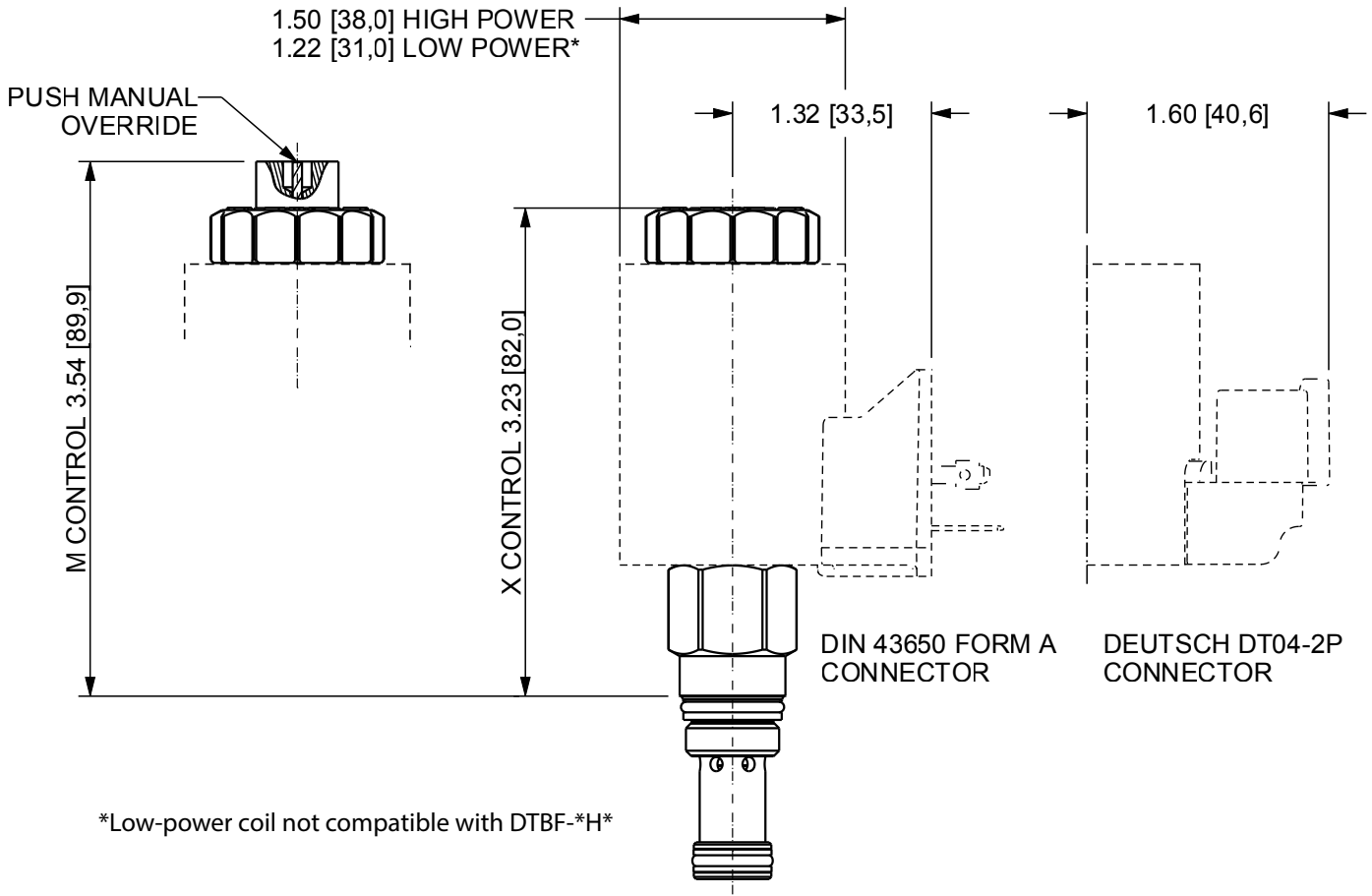

747 SERIES HAZARDOUS LOCATION COILS

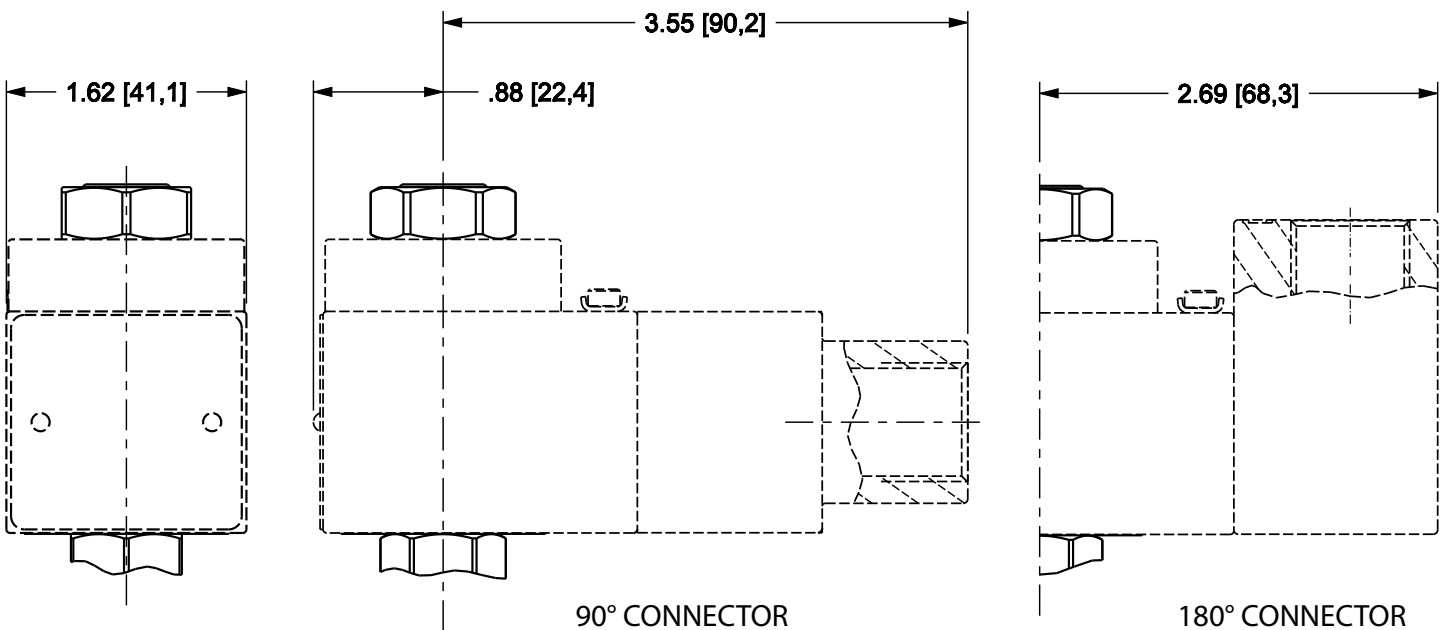

NOTE: Please verify cartridge clearance requirements when choosing a Sun manifold. Different valve controls and coils require different clearances. An additional minimum 2.0 in. (50,8 mm) beyond the valve extension is needed for coil installation and removal.

T-162A CAVITY DIMENSIONAL DRAWING

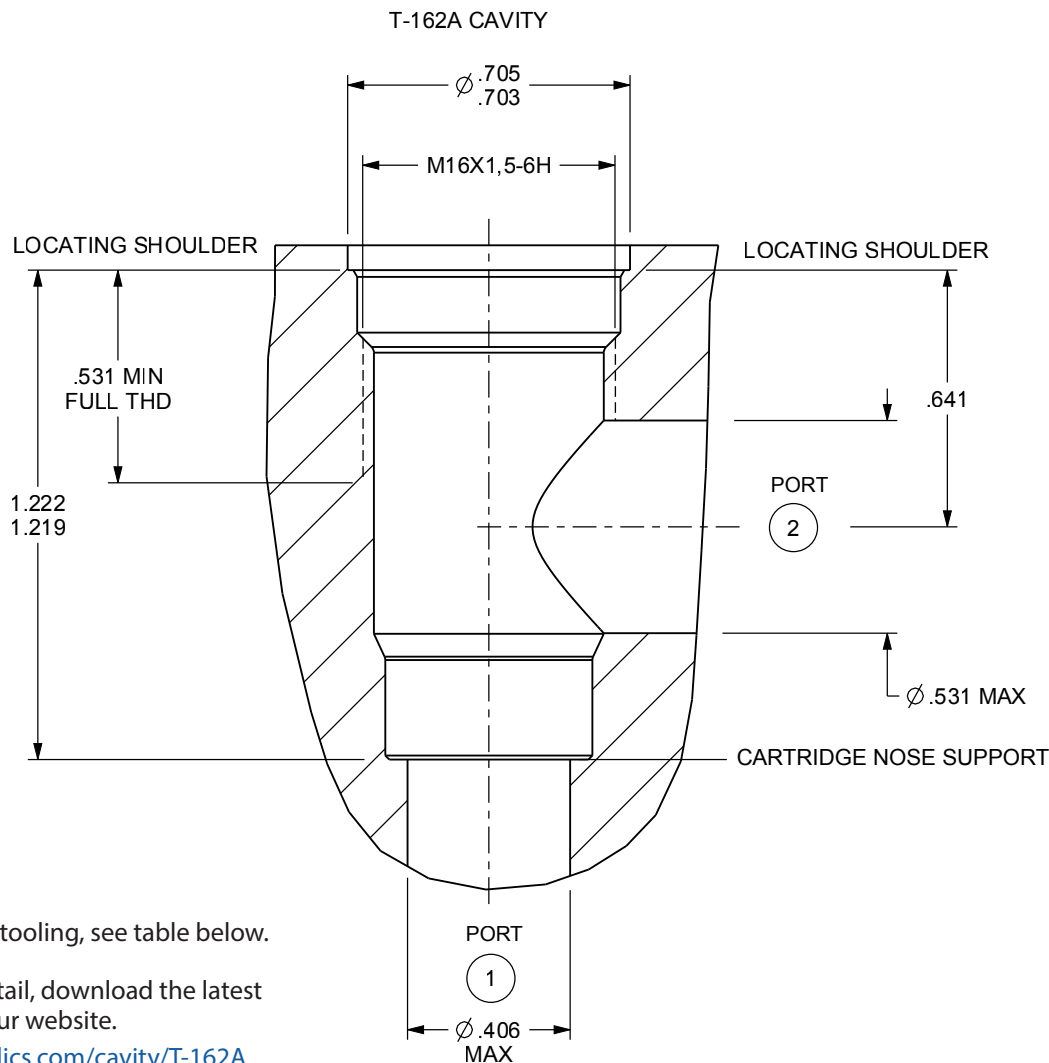

NOTE: For cavity tooling, see table below.

For full cavity detail, download the latest drawings from our website.

www.sunhydraulics.com/cavity/T-162A

T-162A CAVITY TOOLING

DESCRIPTION	HIGH-SPEED STEEL	TITANIUM COATED
M16 X 1.5-6H tap, straight shank	998991	998991101
Series 0 deep hex socket	998100005	
T-162A cavity form drill, morse taper	994162001	994162101
T-162A cavity form drill, straight shank		994162102
T-162A cavity form reamer, morse taper	995162001	995162101
T-162A cavity form reamer, straight shank		995162102

ADDITIONAL INFORMATION

ACCESSORIES

DESCRIPTION	PART NUMBER
Wire harness, 2-pin Deutsch-to-Metri-Pack Conversion	991-717
Wire harness, 2-pin Deutsch-to-Amp Jr Timer Conversion	991-718
Wire harness, 2-pin Deutsch-to-Twin-Lead Conversion	991-719

STANDARD LINE-MOUNT & SANDWICH MANIFOLDS

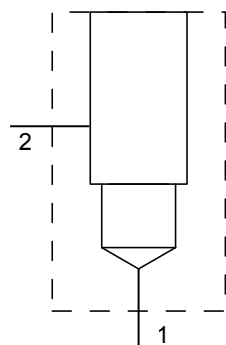

Compatible with the DFB* family of FLEx valves, Sun Hydraulics offers 31 standard line-mount manifolds in 90°, in-line, through port 1 with gauge port, cross port and direct mount (banjo bolt) versions for the T-162A cavity. Standard products include one- and two-cavity versions in a wide range of port sizes. The popular AAJ model line-mount 90° manifold (shown at left) has a single cavity and SAE 8 ports.

In sandwich manifolds, we offer 26 standard bodies based on the T-162A cavity that include a range of interfaces in one- or two-cavity versions.

To search our complete line of standard manifolds, go to www.SunHydraulics.com/models/manifolds.



Sun Hydraulics Headquarters
Sarasota, Florida USA
(1) 941 362 1200
suninfo@sunhydraulics.com

Sun Hydraulics Limited
Coventry England
+44 2476 217 400
sales@sunuk.com

Sun Hydraulik GmbH
Erkelenz Germany
+49 2431 80910
sales@sunhydraulik.de

Sun Hydraulics Corp. (India)
Bangalore India
+91 8028 456325
sunindiainfo@sunhydraulics.com

Sun Hydraulics Korea Corp.
Incheon Korea
+82 3281 31350
sales@sunhydraulics.co.kr

Sun Hydraulics China Co. Ltd.
Shanghai P.R. China
+86 2151 162862
sunchinainfo@sunhydraulics.com

Sun Hydraulics Corp. (S.America)
Rosario, Argentina
+54 9 341 584 3075
ventas@sunhydraulics.com

October 2017